



Scania S, R, G, P cabs, 2016-

Art. 2761788 (864490), 2761789 (864491)

Rammraud FIN WING | Truck cattleguard FIN WING | Передняя дуга FIN WING | LKW Bullfänger FIN WING



1. Rammraud / cattle guard / передняя дуга / Bullfänger	1	20. Polt / bolt / болт / Bolzen M10x30 DIN 933	10
2. Kronstein / bracket / кронштейн / Konsole	1	21. Polt / bolt / болт / Bolzen M10x30 DIN 7991	6
3. Kronstein / bracket / кронштейн / Konsole	1	22. Polt / bolt / болт / Bolzen M12x30	8
4. Kronstein / bracket / кронштейн / Konsole	1	23. Polt / bolt / болт / Bolzen M8x25 DIN 7991	2
5. Kronstein / bracket / кронштейн / Konsole	1	24. Polt / bolt / болт / Bolzen M8x25 DIN 933	2
6. Kronstein / bracket / кронштейн / Konsole	2	25. Liblikpolt / butterfly bolt / бабочка болт / Schmetterling Bolzen	2
7. Kronstein / bracket / кронштейн / Konsole	1	26. Mutter / nut / гайка / Mutter M10	20
8. Kronstein / bracket / кронштейн / Konsole	1	27. Puks / bushing / букса / Buchse	2
9. Kronstein / bracket / кронштейн / Konsole	1	28. Seib / washer / шайба / Scheibe 20x37x3	2
10. Kronstein / bracket / кронштейн / Konsole	1	29. Seib / washer / шайба / Scheibe 13x24x2,5	2
11. Kronstein / bracket / кронштейн / Konsole	1	30. Seib / washer / шайба / Scheibe 10,5x30x2,5	20
12. Laterna kinnituskronstein / lamp fixing bracket / крепежный кронштейн лампы / Lampenbefestigungsklammer	4	31. Seib / washer / шайба / Scheibe 10,5x20x2	12
13. Laterna kinnituskronstein / lamp fixing bracket / крепежный кронштейн лампы / Lampenbefestigungsklammer	4	32. Seib / washer / шайба / Scheibe 8,4x16x1,6	2
14. Puks / bushing / букса / Buchse	2	33. Seib / washer / шайба / Scheibe 6,4x18x1,6	2
15. Plaat / plate / пластина / Platte	8	34. Vedruseib / spring washer / пружинная шайба / Federnscheibe A20	2
16. Polt / bolt / болт / Bolzen M20x170	2	35. Vedruseib / spring washer / пружинная шайба / Federnscheibe A12	2
17. Polt / bolt / болт / Bolzen M12x170	2	36. Vedruseib / spring washer / пружинная шайба / Federnscheibe A10	2
18. Polt / bolt / болт / Bolzen M20x40	2	37. Vedruseib / spring washer / пружинная шайба / Federnscheibe A8	2
19. Polt / bolt / болт / Bolzen M10x70	2	38. Vedruseib / spring washer / пружинная шайба / Federnscheibe A5	2
.		39*. Polt / bolt / болт / Bolzen M20x220	2
		40*. Kronstein / bracket / кронштейн / Konsole	1
		41*. Kronstein / bracket / кронштейн / Konsole	1
		42*. Kronstein / bracket / кронштейн / Konsole	1
		43*. Kronstein / bracket / кронштейн / Konsole	1
		44. Kummiseib / rubber washer / резиновая шайба / Gummisscheibe	6

* - for protruding bumper

M6 - 11 Nm
M8 - 25 Nm
M10 - 50 Nm
M12 - 90 Nm
M20 - 245 Nm

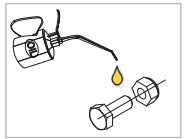

Kaal / Weight / Масса / Gewicht: 88,1 kg

Paigaldusaeg / Time of mounting / Время установки / Einbauzeit: 120 min

Vajalikud tööriistad / Required Tools / Необходимые инструменты / Benötigte Werkzeuge



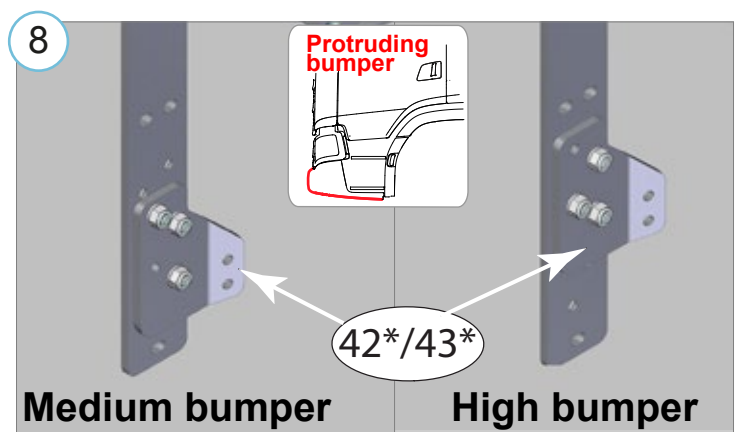
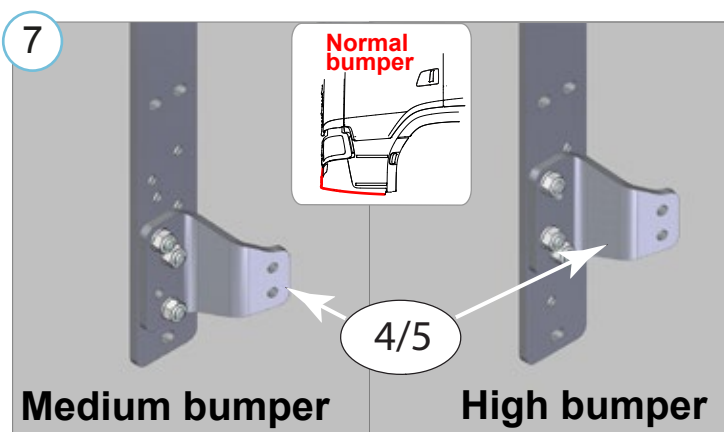
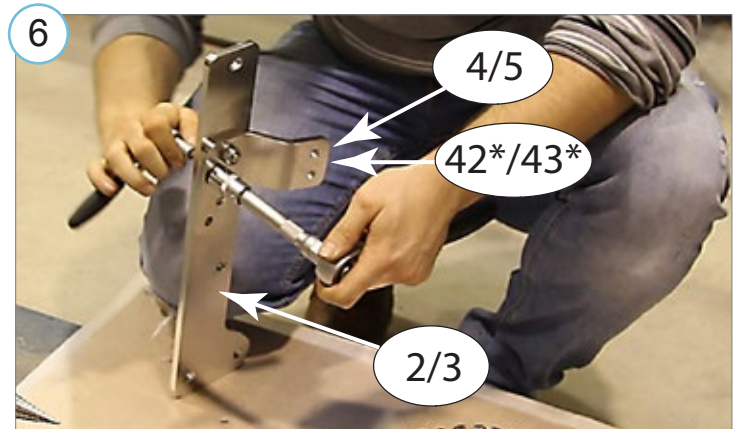
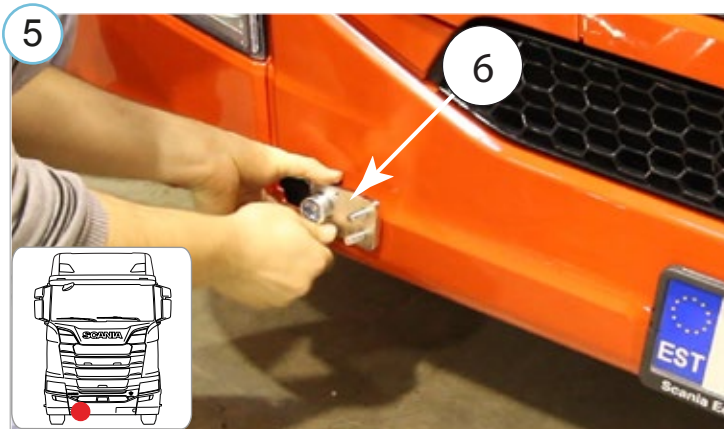
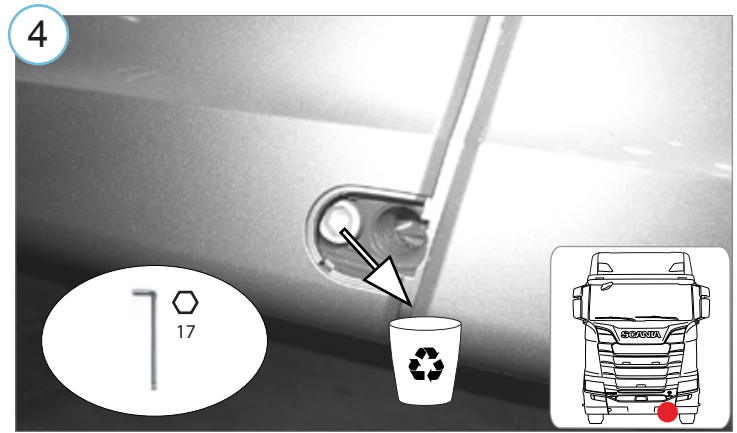
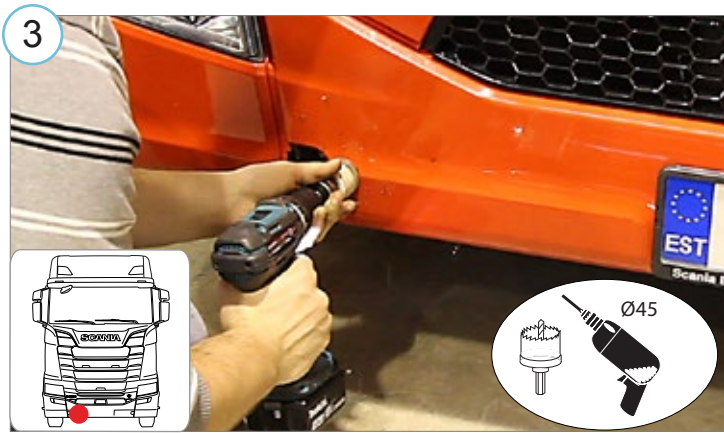
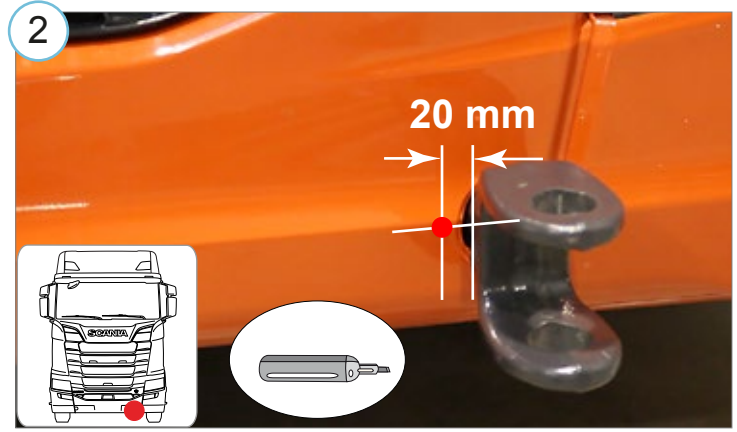
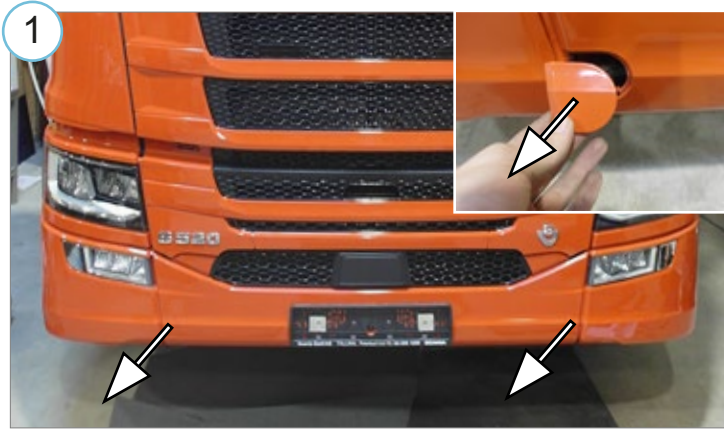

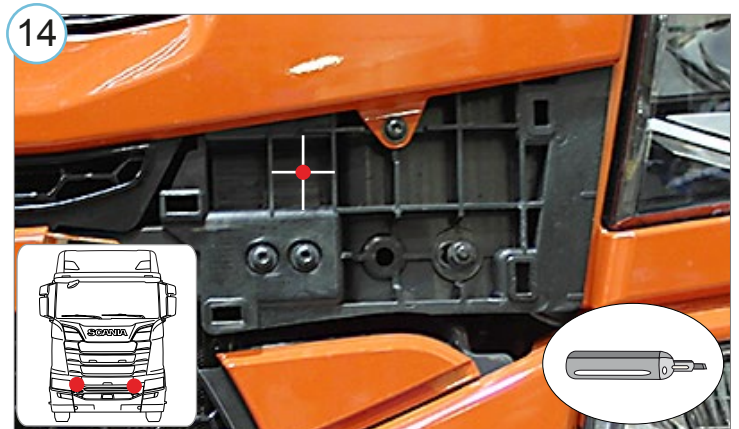
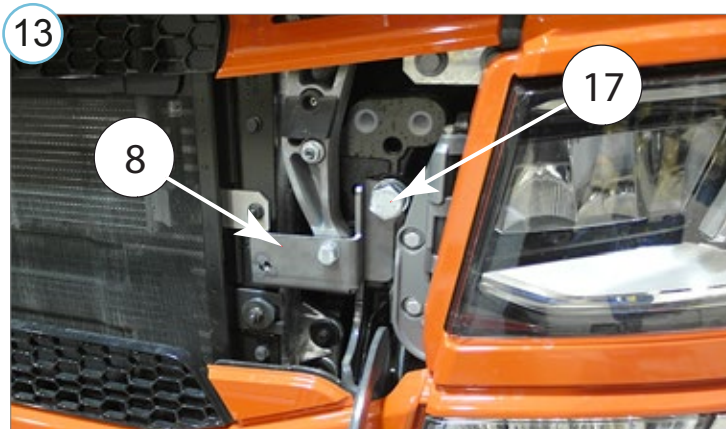
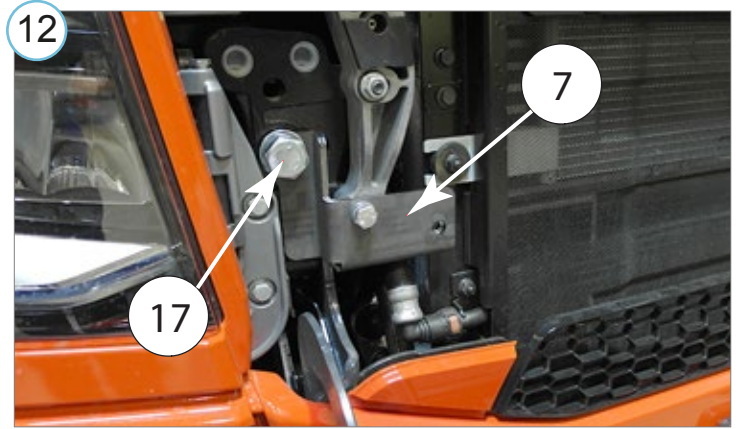
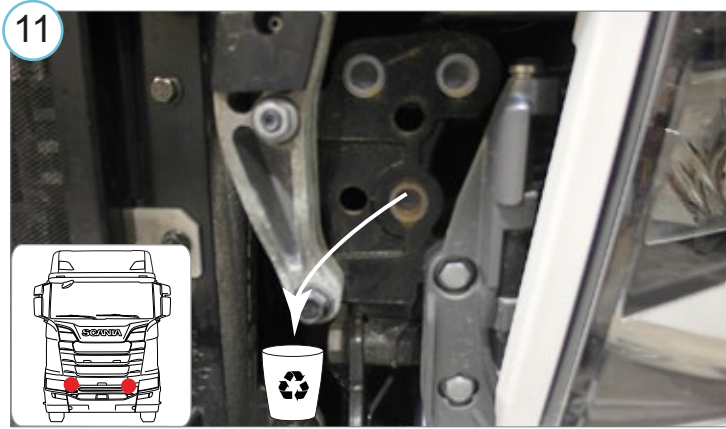
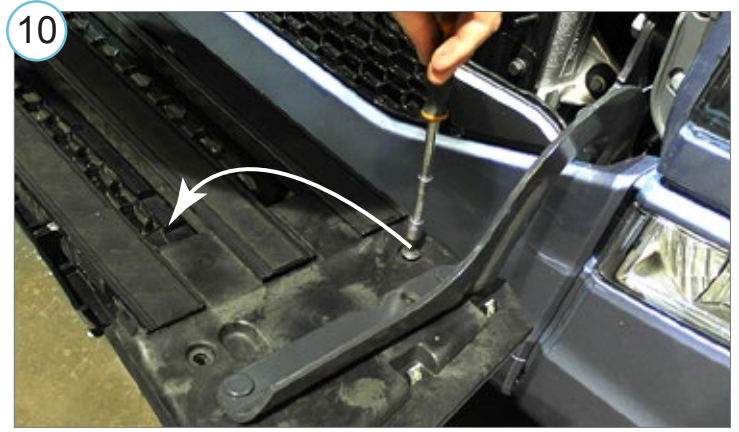

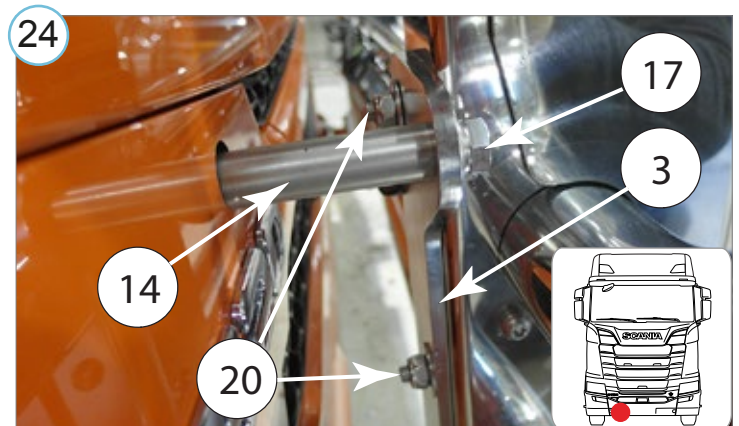
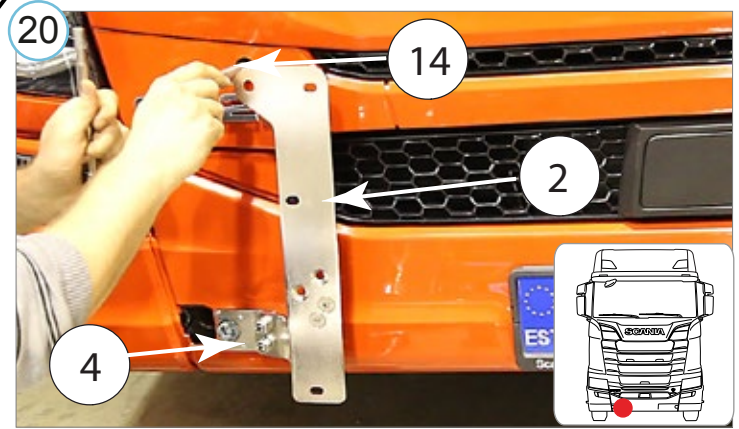
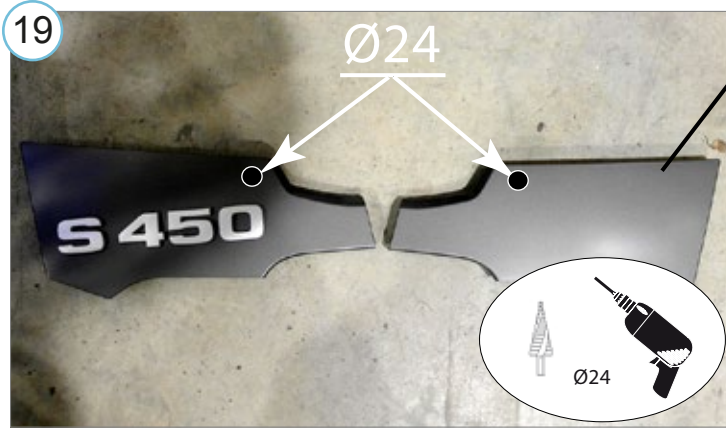
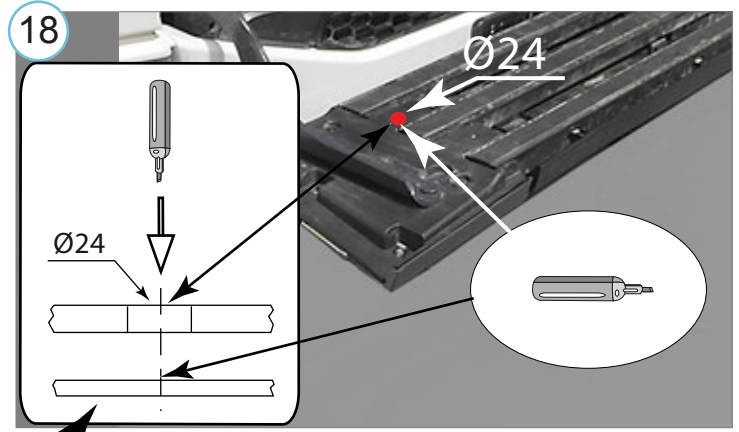

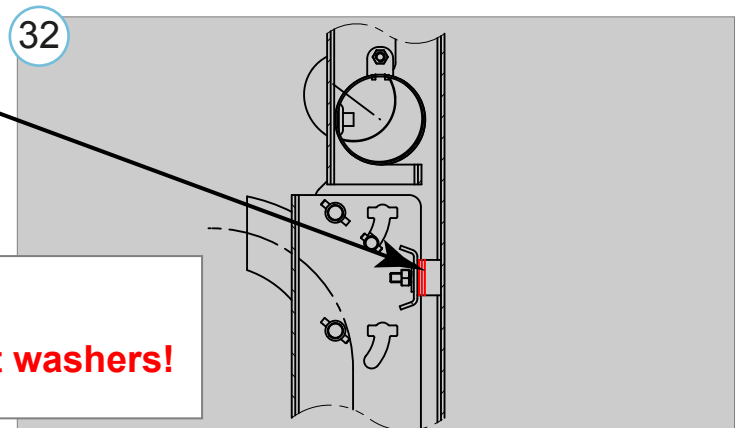
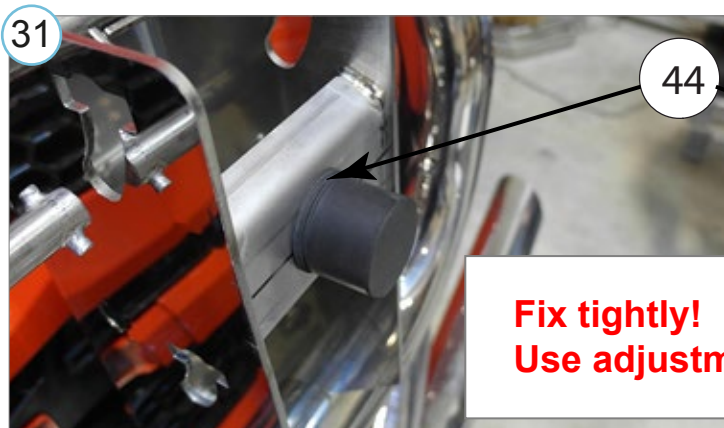
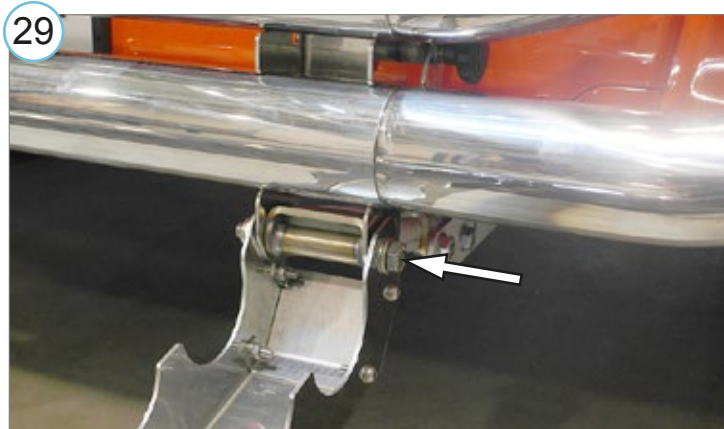
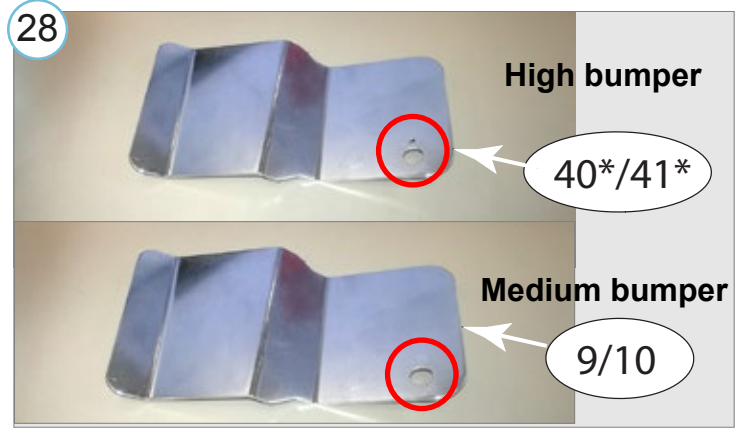
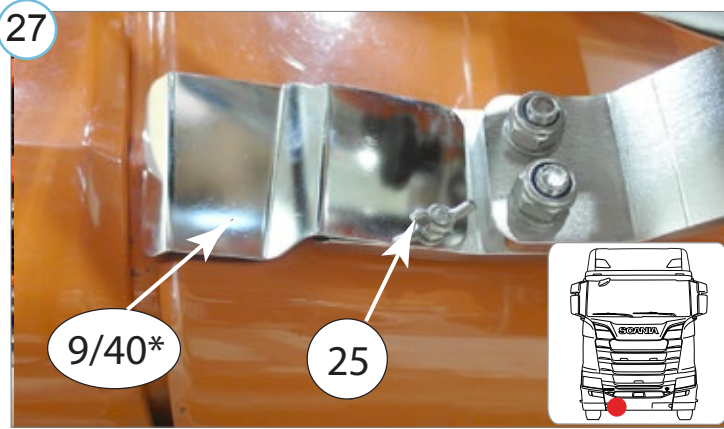
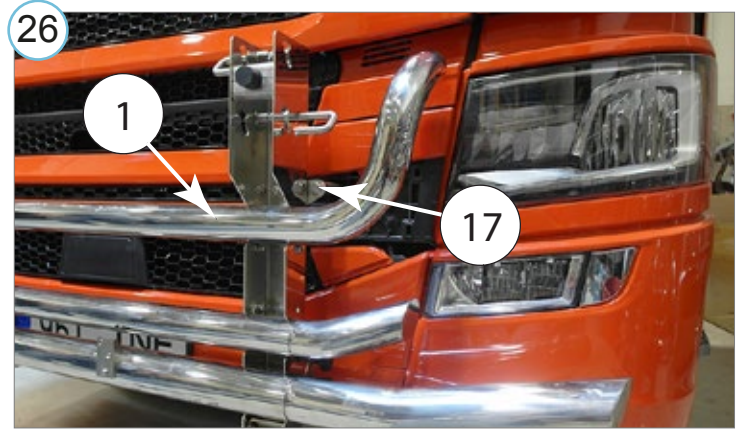
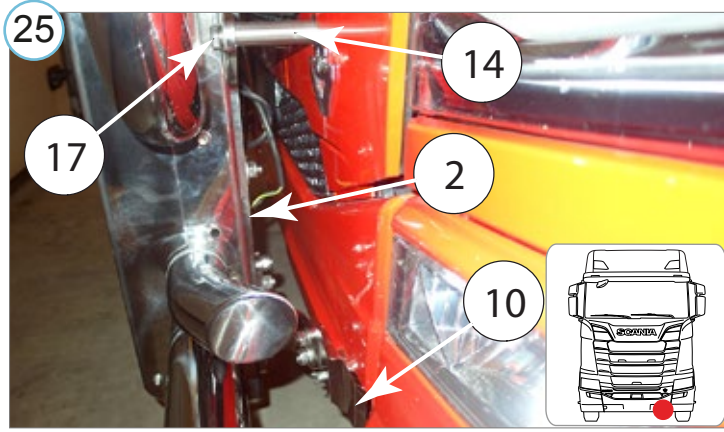

**Fix tightly!
Use adjustment washers!**

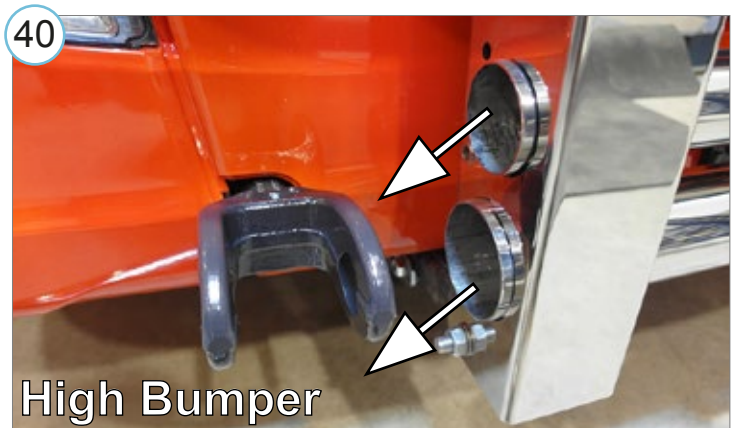
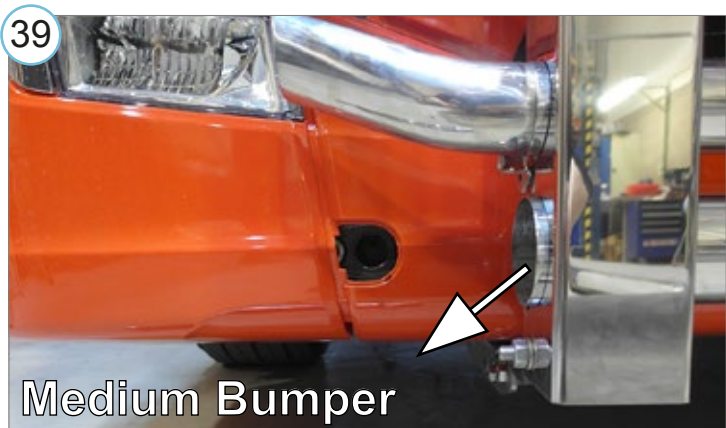
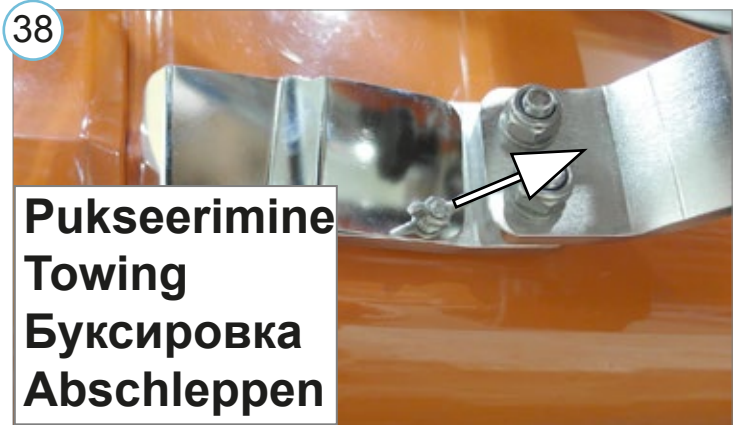
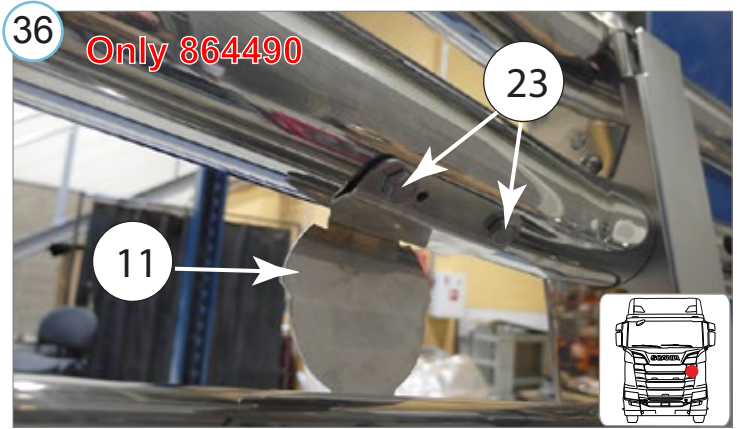
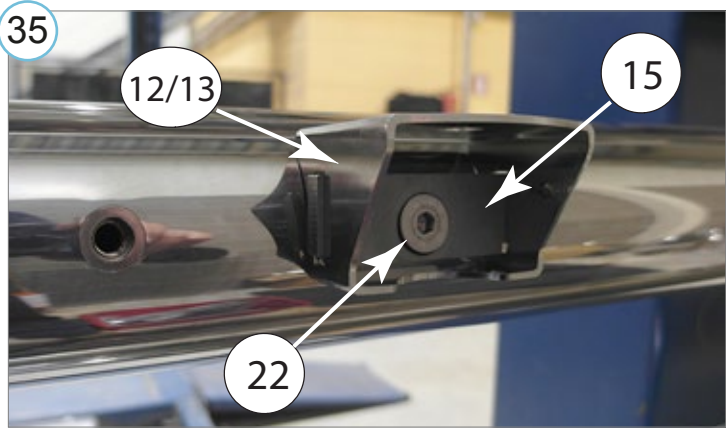
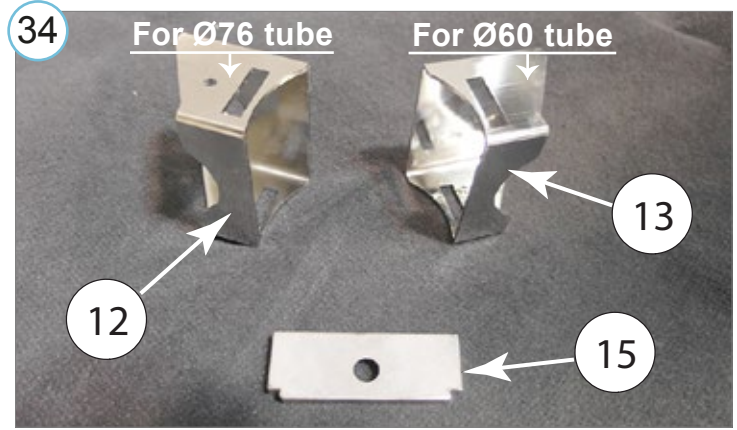
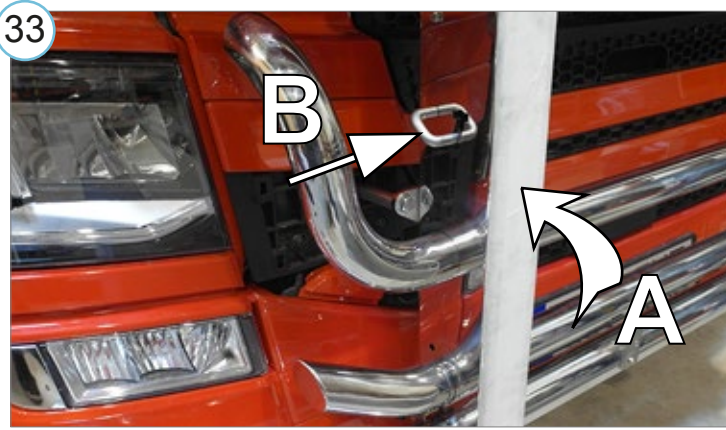

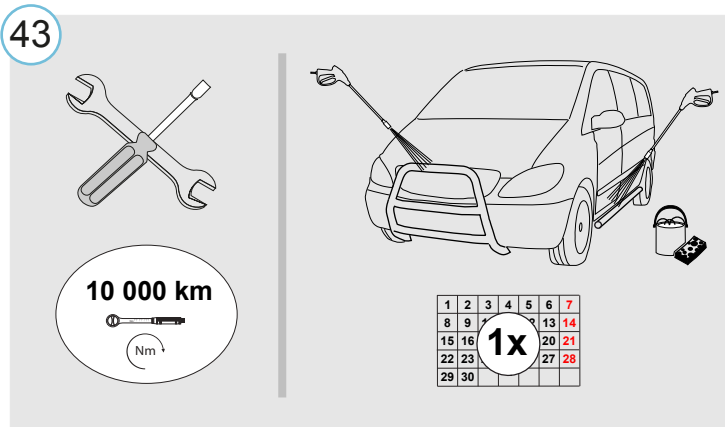

Lisa /extra / приложение / Extra

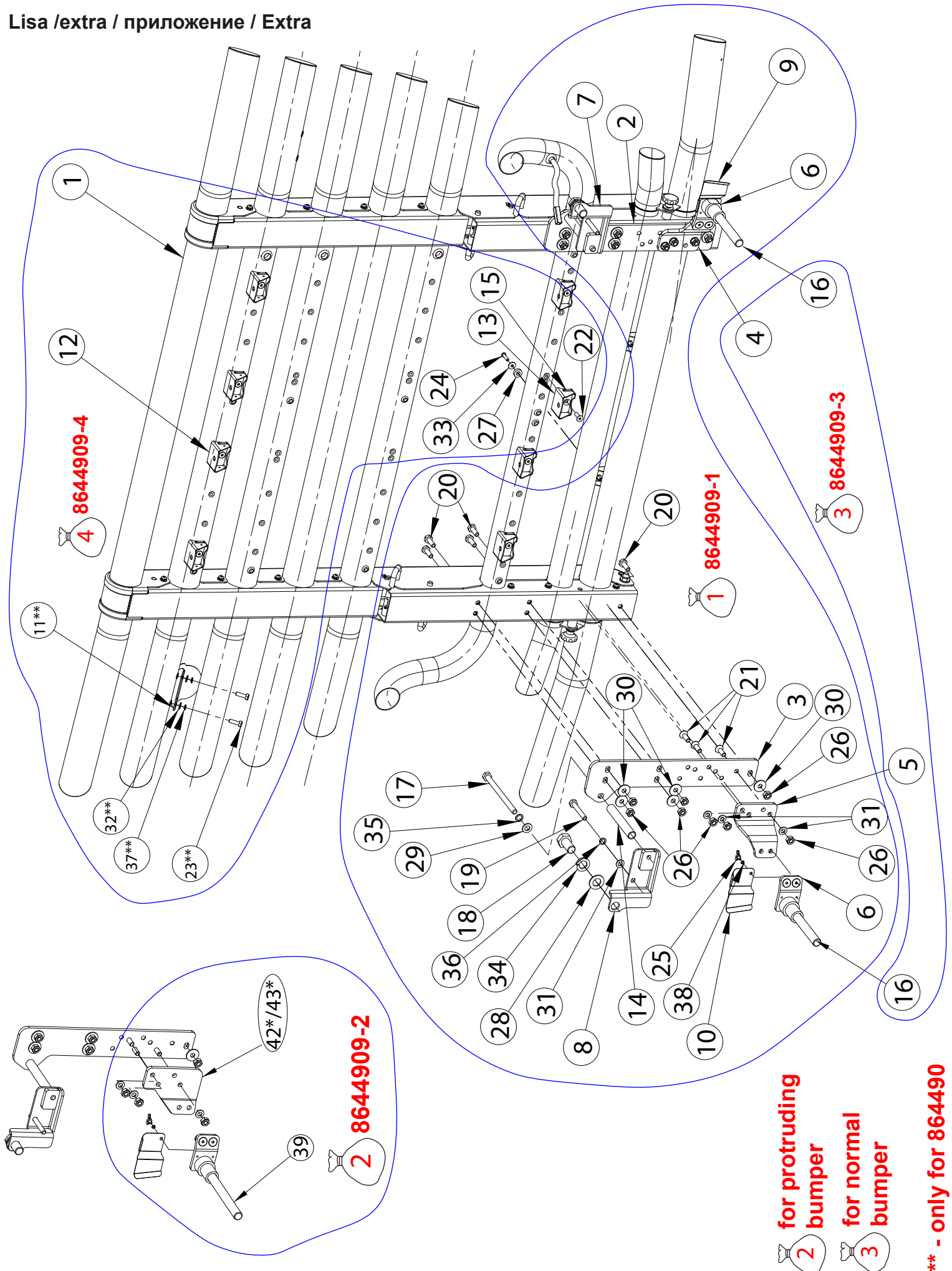

2 for protruding bumper
3 for normal bumper

**** - only for 864490**